

EM1 Transmissive Optical Encoder Module

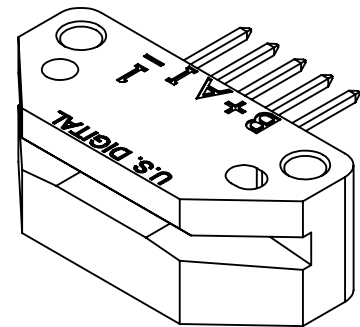

RELEASE DATE: 02/07/2022

