

E2 Features

- Quick, simple assembly, and disassembly
- Rugged screw-together housing
- Accepts .010 in. axial shaft play
- 32 to 5,000 cycles per revolution (CPR)
- 128 to 20,000 pulses per revolution (PPR)
- 2 channel quadrature TTL squarewave outputs
- Optional index (3rd channel)
- Mounting compatibility with HEDS-5500



E2 Product Description

The E2 is a rotary encoder with a rugged glass-filled polymer enclosure, which utilizes either a 5-pin locking or standard connector. The internal components consist of a mylar disk mounted to a precision machined aluminum hub and an encoder module. The module contains a highly collimated solid-state light source and monolithic phased array sensor, which together provide a system extremely tolerant to mechanical misalignments.



The E2 is normally designed for applications of 10 feet or less. For applications requiring longer cable lengths, we recommend adding a PC4 (<https://www.usdigital.com/pc4/>) / PC5 (<https://www.usdigital.com/pc5/>) differential line driver or check out our E5 (<https://www.usdigital.com/products/encoders/incremental/kit/e5/>) which has an optional differential output.

Attachment of the base to a surface may be accomplished by utilizing one of several machine screw bolt circle options. Positioning of the base to the centerline of a shaft is ensured by the use of our centering tool. The cover is securely attached to the base with two 4-40 pan head screws to provide a resilient package protecting the internal components.

Connection to the E2 product is made through either a 5-pin locking or standard connector. The mating connectors are available from US Digital with several cable options and lengths.

BROADCOM/AVAGO REPLACEMENTS:

US Digital's E2 encoder may be used as direct replacements (<https://www.usdigital.com/support/resources/reference/compatibility-guides/us-digital-e2-compatibility-guide-for-broadcomavagoagilenthp-heds-5xxx-encoder/>) for Avago HEDM-5500, HEDM-5600, (<https://www.usdigital.com/support/resources/reference/compatibility-guides/us-digital-e2-compatibility-guide-for-broadcomavagoagilenthp-hedm-5x0x-encoder/>) HEDS-5500, HEDS-5600 (<https://www.usdigital.com/support/resources/reference/compatibility-guides/us-digital-e2-compatibility-guide-for-broadcomavagoagilenthp-heds-5xxx-encoder/>).

Mechanical Drawings

E2 Optical Kit Encoder (Default)

RELEASE DATE: 7/19/2019

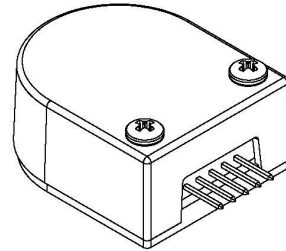
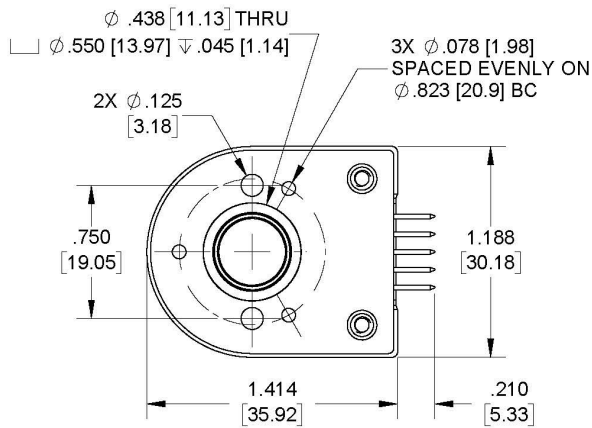
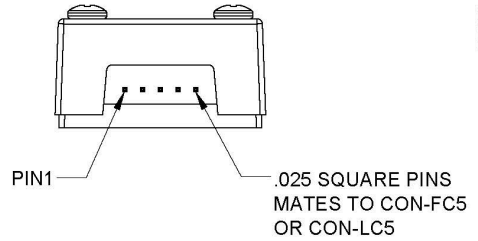
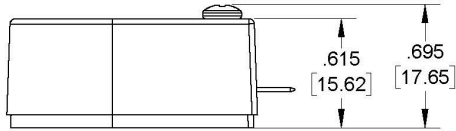

US DIGITAL 1400 NE 136th Avenue
Vancouver, Washington 98684, USA

info@usdigital.com
www.usdigital.com

Local: 360.260.2468
Toll-free: 800.736.0194

UNITS: INCHES [MM]
METRIC SHOWN FOR REFERENCE ONLY

E2 Optical Kit Encoder (Base and Cover Options)

E-OPTION COVER
(EXTENSION FOR SHAFT
LENGTHS UP TO .805 [20.45])

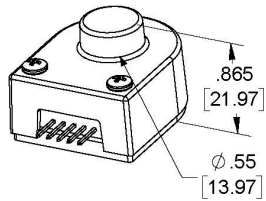

H-OPTION COVER
(HOLE FOR SHAFT
LENGTHS OVER .805 [20.45])

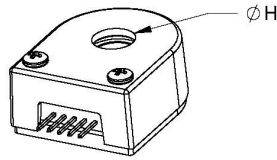

H = .375 [9.53] FOR SHAFT SIZES ≤ Ø .315 [8]
H = .500 [12.70] FOR BORE SIZES > Ø .315 [8]

3-OPTION BASE
(LARGER MOUNTING HOLES)

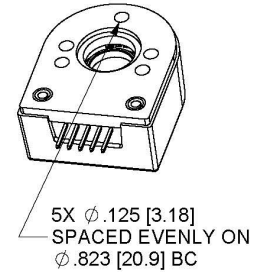

A-OPTION BASE
(ALIGNMENT BOSS)

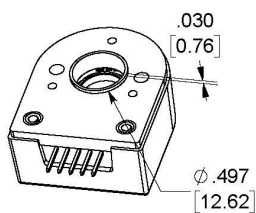

G-OPTION BASE
(1.812 MOUNTING)

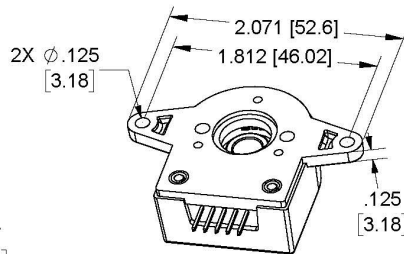

R-OPTION BASE
(ROTATIONAL MOUNTING)

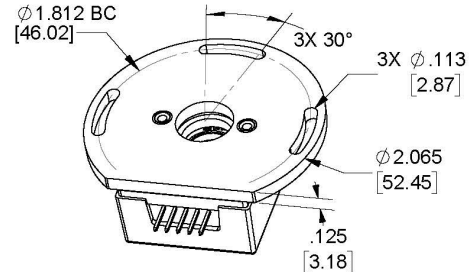

REQUIRES ADDITIONAL .125 [3.18] SHAFT LENGTH

RELEASE DATE: 7/19/2019

US DIGITAL 1400 NE 136th Avenue
Vancouver, Washington 98684, USA

info@usdigital.com
www.usdigital.com

Local: 360.260.2468
Toll-free: 800.736.0194

UNITS: INCHES [MM]
METRIC SHOWN FOR REFERENCE ONLY

Specifications

ENVIRONMENTAL

| PARAMETER | VALUE | UNITS |
|--|------------|-------|
| Operating Temperature, CPR < 2000 | -40 to 100 | C |
| Operating Temperature, CPR ≥ 2000 | -25 to 100 | C |
| Electrostatic Discharge, IEC 61000-4-2 | ± 4 | kV |
| Vibration (10Hz to 2kHz, sinusoidal) | 20 | G |
| Shock (6 milliseconds, half-sine) | 75 | G |

MECHANICAL

| PARAMETER | VALUE | UNITS |
|--|--|---|
| Max. Shaft Axial Play | ±0.010 | in. |
| Max. Shaft Runout | 0.004 T.I.R. | in. |
| Max. Acceleration | 250000 | rad/sec ² |
| For CPR ≤ 1250: Max. RPM (1) Max. A/B Frequency e.x. CPR=1250, Max. RPM=14400 e.x. CPR=100, Max. RPM=60000 | minimum value of ((18 x 10 ⁶) / CPR) and (60000) 300 | RPM kHz |
| For CPR = 2000, 2048, 2500: Max. RPM (1) Max. A/B Frequency | minimum value of ((21.6 x 10 ⁶) / CPR) and (60000) 360 | RPM kHz |
| For CPR = 4000, 4096, 5000: Max. RPM (1) Max. A/B Frequency | minimum value of ((43.2 x 10 ⁶) / CPR) and (60000) 720 | RPM kHz |
| Typical Product Weight | 0.56 | oz. |
| Codewheel Moment of Inertia | 8.0 x 10 ⁻⁶ | oz-in-s ² |
| Hub Set Screw | #4-48 | |
| Hex Wrench Size | 0.050 | in. |
| Encoder Base plate Thickness | 0.135 | in. |
| 3 Mounting Screw Size | #0-80 | |
| 2 Mounting Screw Size | #2-56 or #4-40 | |
| 3 Screw Bolt Circle Diameter | 0.823 ± 0.005 | in. |
| 2 Screw Bolt Circle Diameter | 0.750 ± 0.005 | in. |
| Required Shaft Length (2)(3) With E-option (3) With H-option | 0.445 to 0.575 0.445 to 0.805 > 0.445 | in. in. in. |
| Index Alignment to Hub Set Screw | 180 Typical | degrees |
| Technical Bulletin TB1001 - Shaft and Bore Tolerances | | Download (https://www.usdigital.com/media/yyvb4qsy/tb_1001.pdf) |

(1) 60000 RPM is the maximum rpm due to mechanical considerations. The maximum rpm due to the module's maximum frequency response is dependent upon the module's resolution (CPR).

(2) Add 0.125" to the required shaft length when using R-option.

(3) Including Axial play.

TORQUE SPECIFICATIONS

| PARAMETER | VALUE | TORQUE |
|---|-------|--------|
| Hub Set Screw | 2-3 | in-lbs |
| Cover Screw | 2-4 | in-lbs |
| Base Mounting Screw (#0-80) | 1-2 | in-lbs |
| Base Mounting Screw (#2-56) | 2-3 | in-lbs |
| Base Mounting Screw (#4-40) | 4-6 | in-lbs |
| Adapter Plate Mounting Surface (#2-56 screws) | 2-3 | in-lbs |
| Adapter Plate Mounting Surface (#4-40 screws) | 4-6 | in-lbs |

PHASE RELATIONSHIP

B leads A for clockwise shaft rotation, and A leads B for counterclockwise rotation viewed from the cover side of the encoder.

ELECTRICAL

- Specifications apply over the entire operating temperature range.
- Typical values are specified at $V_{cc} = 5.0V_{dc}$ and $25^{\circ}C$.
- For complete details, see the EM1 (<https://www.usdigital.com/products/encoders/incremental/modules/em1/>) or EM2 (<https://www.usdigital.com/products/encoders/incremental/modules/em2/>) product pages.

| PARAMETER | MIN. | TYP. | MAX. | UNITS | CONDITIONS |
|----------------------------|------|------|------|-------|--|
| Supply Voltage | 4.5 | 5.0 | 5.5 | V | |
| Supply Current | 27 | 33 | | mA | CPR < 500, no load |
| | 54 | 62 | | mA | CPR ≥ 500 and < 2000, no load |
| | 72 | 85 | | mA | CPR ≥ 2000, no load |
| Low-level Output | | 0.5 | | V | I _{OL} = 8mA max., CPR < 2000 |
| | | 0.5 | | V | I _{OL} = 5mA max., CPR ≥ 2000 |
| | 0.25 | | | V | no load, CPR ≥ 2000 |
| High-level Output | 2.0 | | | V | I _{OH} = -8mA max. and CPR < 2000 |
| | 2.0 | | | V | I _{OH} = -5mA max. and CPR ≥ 2000 |
| | 4.8 | | | V | no load and CPR < 2000 |
| | 3.5 | | | V | no load and CPR ≥ 2000 |
| Output Current Per Channel | -8 | 8 | | mA | CPR < 2000 |
| | -5 | 5 | | mA | CPR ≥ 2000 |
| Output Rise Time | 110 | | | nS | CPR < 2000 |
| | 50 | | | nS | CPR ≥ 2000, ± 5mA load |
| Output Fall Time | 100 | | | nS | CPR < 2000 |
| | 50 | | | nS | CPR ≥ 2000, ± 5mA load |

PIN-OUT

| PIN | DESCRIPTION |
|-----|-------------|
| 1 | Ground |
| 2 | Index |
| 3 | A channel |
| 4 | +5VDC power |
| 5 | B channel |

Note: 5-pin single-ended mating connector is CON-C5 (<https://www.usdigital.com/products/accessories/connectors/con-c5/>) or CON-LC5 (<https://www.usdigital.com/products/accessories/connectors/con-lc5/>)

ACCESSORIES

1. Centering Tool

Part #: CTOOL - (Shaft Diameter)

This reusable tool centers the shaft within the encoder base during assembly. It must be used for the proper functioning of the encoder.

2. Hex Tool

Part #: HEXD-050

Hex driver, 0.050" flat-to-flat for #3-48 or #4-48 set screws. Included with **-B** or **-1** packaging options for order quantities of 10 or more.

Part #: HEXW-050

Hex wrench, 0.050" flat-to-flat for #3-48 or #4-48 set screws. Included with **-B** or **-1** packaging options for order quantities of 9 or less. Included with **-3** packaging option for all order quantities.

3. Spacer Tool

Part #: SPACER-E2

This reusable tool sets the correct spacing between the disk and sensor during assembly. It must be used for the proper functioning of the encoder.

4. Screws

Part #: SCREW-080-250-PH

Description: Pan Head, Philips #0-80 UNF x 1/4"

Use: Base Mounting

Quantity Required: 3

Screws are not included

Part #: SCREW-256-250-PH

Description: Pan Head, Philips #2-56 UNC x 1/4"

Use: Base Mounting

Quantity Required: 2

Screws are not included

Part #: SCREW-440-250-PH

Description: Pan Head, Philips #4-40 UNC x 1/4"

Use: Base Mounting

Quantity Required: 2

Screws are not included

Part #: SCREW-440-625-PH

Description: Pan Head, Phillips 4-40 UNC x 5/8"

Use: Cover Mounting

Quantity Required: 2

Screws are included

Part #: SCREW-448-063-SS

Description: Socket Head Set Screw, 4-48 UNC x 1/16"

Use: Hub/Disk Mounting for 5/16" - 10mm Bore

Quantity Required: 1

Screw is included

Part #: SCREW-448-125-SS

Description: Socket Head Set Screw, 4-48 UNC x 1/8"

Use: Hub/Disk Mounting for 2mm - 1/4" Bore

Quantity Required: 1

Screw is included

OUTPUT WAVEFORMS

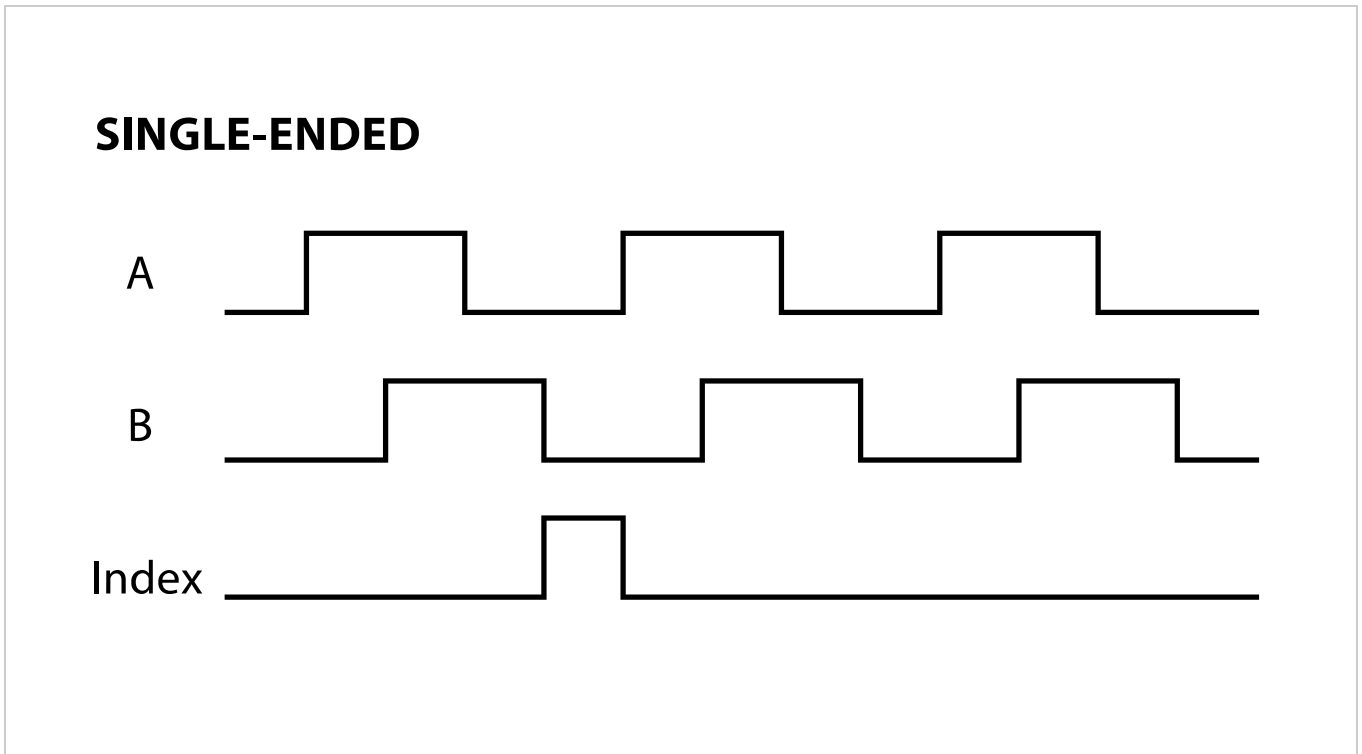

Notes

- US Digital® warrants its products against defects in materials and workmanship for two years. See complete warranty (<https://www.usdigital.com/company/warranty>) for details.
- Cables and connectors are not included and must be ordered separately.

Configuration Options

| E2 | CPR (Cycles Per Revolution) | Bore Size | Index | Cover | Base | Packaging |
|----|--------------------------------|--------------|----------------|------------------|---|--|
| | | 079 (2.0mm) | IE (Index) | D (Default) | D (Default) | B (Encoders packaged in bulk. Every order includes one centering tool, hex tool and spacer tool. An additional set of tools is included for each 100 encoders ordered.) |
| | | 118 (3.0mm) | NE (Non-Index) | E (Extended) | 3 (1/8" Mounting Holes) | 1 (Encoders packaged individually. Every order includes one centering tool, hex tool and spacer tool. An additional set of tools is included for each 100 encoders ordered.) |
| | 32 | 125 (1/8") | | H (Through-Hole) | A (Aligning Shoulder) | 3 (Encoders packaged individually. Every order includes one centering tool, hex tool and spacer tool per encoder.) |
| | 50 | 156 (5/32") | | | G (1.812" Diameter Bolt Circle) | |
| | 96 | 157 (4.0mm) | | | R (1.812" Diameter Bolt Circle, 3 Slot Rotational Mounting) | |
| | 100 | 188 (3/16") | | | | |
| | 120 | 197 (5.0mm) | | | | |
| | 192 | 236 (6.0mm) | | | | |
| | 200 | 250 (1/4") | | | | |
| | 250 | 276 (7.0mm) | | | | |
| | 256 | 313 (5/16") | | | | |
| | 360 | 315 (8.0mm) | | | | |
| | 400 | 375 (3/8") | | | | |
| | 500 | 394 (10.0mm) | | | | |
| | 512 | | | | | |
| | 540 | | | | | |
| | 720 | | | | | |
| | 800 | | | | | |
| | 900 | | | | | |
| | 1000 | | | | | |
| | 1024 | | | | | |
| | 1250 | | | | | |
| | 2000 | | | | | |
| | 2048 | | | | | |
| | 2500 | | | | | |
| | 4000 | | | | | |
| | 4096 | | | | | |
| | 5000 | | | | | |

PLEASE NOTE: This chart is for informational use only. Certain product configuration combinations are not available. Visit the E2 product page (<https://www.usdigital.com/products/E2>) for pricing and additional information.